

## IOLAN SDG4/SDG4 TX/STG4 Hardware Installation Guide



THE SPECIFICATIONS AND INFORMATION REGARDING THE PRODUCTS IN THIS GUIDE ARE SUBJECT TO CHANGE WITHOUT NOTICE. ALL STATEMENTS, INFORMATION, AND RECOMMENDATIONS IN THIS GUIDE ARE BELIEVED TO BE ACCURATE BUT ARE PRESENTED WITHOUT WARRANTY OF ANY KIND, EXPRESS OR IMPLIED. USERS MUST TAKE FULL RESPONSIBILITY FOR THEIR APPLICATION OF ANY PRODUCTS.

This equipment has been tested and found to comply with the limits for a Class A digital device, pursuant to part 15 of the FCC rules. These limits are designed to provide reasonable protection against harmful interference when the equipment is operated in a commercial environment. This equipment generates, uses, and can radiate radio-frequency energy and, if not installed and used in accordance with this hardware guide may cause harmful interference to radio communications. Operation of this equipment in a residential area is likely to cause harmful interference, in which case users will be required to correct the interference at their own expense.

Modifications to this product not authorized by Perle could void the FCC approval and negate your authority to operate the product.

Perle reserves the right to make changes without further notice, to any products to improve reliability, function, or design.

Perle, the Perle logo, and IOLAN SDG4/SDG4 TX/STG4 are trademarks of Perle Systems Limited.

©2023. Perle Systems Limited.

# Table of Contents

Hardware .....	2
Preface .....	2
Overview .....	3
IOLAN SDG4/SDG4 TX/STG4 (Top View) .....	3
IOLAN SDG4/STG4 (Side View with Barrel connector) .....	4
IOLAN SDG4 TX (Side View with Terminal Block Connector) .....	4
Ethernet and Serial Ports .....	4
Button/Switch Functions .....	4
LED Indicators .....	5
Installation .....	6
Connecting the Power .....	6
Connecting the Serial Ports .....	7
Connecting Data Ports .....	8
Operation .....	10
Rebooting the IOLAN .....	10
Resetting the IOLAN to Factory Default Configuration .....	10
Configuring the IOLAN .....	11
Appendix A - Technical Specifications .....	12
Appendix B - Mechanical Drawing .....	13
Appendix C - Labels (Sample) .....	14
Appendix D - Cabling and Connectors .....	15
Appendix E - IOLAN Maintenance .....	17
Contacting Perle Systems Limited .....	18

# Hardware

## Preface

### Audience

This guide is for the network or computer technician responsible for installing the Perle IOLAN SDG4/SDG4 TX/STG4. Familiarity with the concepts and terminology of Ethernet and local area networks is required.

### Purpose

This document describes the hardware and physical characteristics of the Perle IOLAN SDG4/SDG4 TX/STG4. It covers hardware features as well as installation and operation of the IOLAN. This document does not cover how to configure your Perle IOLAN SDG4/SDG4 TX/STG4.

Information to configure your Perle IOLAN SDG can be found in the IOLAN User's Guide.

### Document Conventions

This document contains the following conventions:

Most text is presented in the typeface used in this paragraph. Other typefaces are used to help you identify certain types of information. The other typefaces are:

**Note:** *Means reader take note:* notes contain helpful suggestions.

**Caution:** Means reader be careful. In this situation, you might perform an action that could result in equipment damage or loss of data.

#### **Warning: IMPORTANT SAFETY INSTRUCTIONS**

Means danger. You are in a situation that could cause bodily injury. Before you work on any equipment, be aware of the hazards involved with electrical circuitry and be familiar with standard practices for preventing accidents. Only qualified personnel should connect power to this unit.



Warning – more information is contained within this guide



Warning – equipment rated above 40°C. Equipment may be very hot.

## Overview

The IOLAN 4 port comes in various models.

- SDG4 - Four RJ45 serial ports
- SDG4 TX - Extended Temperature with four RJ45 serial ports
- STG4 - Four RJ45 serial ports (RS232 only)

**NOTE:** Extended Temperature models can operate in the range of -40 to 74 degrees C.

## IOLAN SDG4/SDG4 TX/STG4 (Top View)

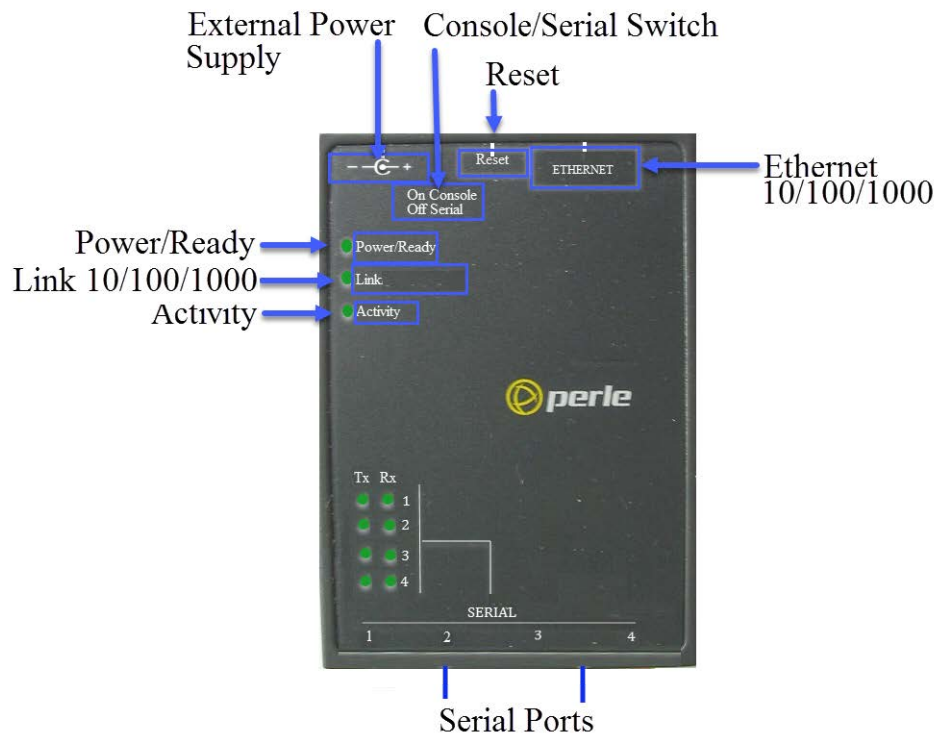

The IOLAN STG4 only supports RS-232 on RJ45-10 pin.

## IOLAN SDG4/STG4 (Side View with Barrel connector)

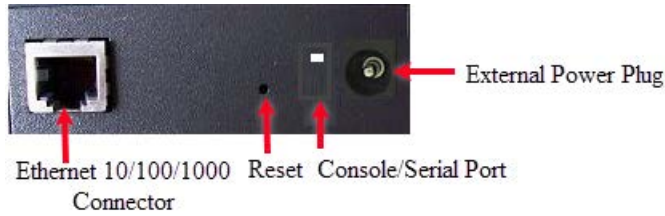

## IOLAN SDG4 TX (Side View with Terminal Block Connector)

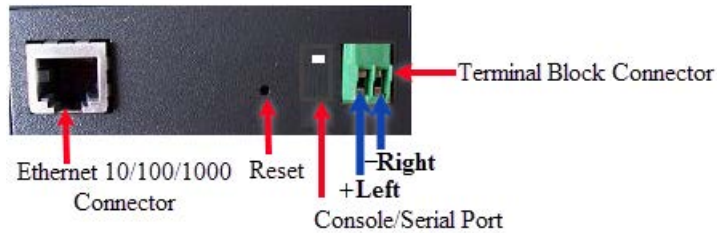

**Note:** Terminal Block is fixed to the IOLAN

## Ethernet and Serial Ports

### 10/100/1000Base-T Port

The Ethernet port provides the standard gigabit Ethernet interface speeds of 10/100/1000 Mbps through twisted pair (UTP) cables of up to 100 meters (328ft) in length.

### Console / Serial Ports

The unit has four, 10 pin, RJ45 ports. All ports can be used to connect a serial device and to provide power out. When used to connect a serial device, the ports can operate in EIA-232, EIA-422 or EIA-485 mode. In addition to connecting a serial device, port 1 can be used as a console port and/or to power the IOLAN. When port 1 is used to connect a console, the port can be used to fully configure and manage the IOLAN. For details on how to connect to the serial ports see [Connecting the Serial Ports](#)

All serial ports can be used to connect a serial device and to provide power out. See [Appendix D - Cabling and Connectors](#) for more details.

## Button/Switch Functions

### Reset Button

The inset “Reset” button will reboot the IOLAN if pushed in and released quickly. It will reset the IOLAN to factory defaults if pushed in and held for more than three seconds. For more details on the operation of the Reset button see [“Rebooting the IOLAN”](#)

### Console / Serial DIP Switch

Serial port 1 can act as a console port or a serial port. The mode of operation is determined by the position of the “console/serial port” DIP switch. The DIP is set in the factory to serial (up position). Unless you plan to attach a console to the IOLAN, leave the

DIP switch in the serial position. In console mode, this port can be used to provide access to the IOLAN management function using the industry standard CLI command set (see [Console Port Mode](#)).

See the IOLAN Command Line Interface Reference Guide for a complete set of the commands available via the console.

## LED Indicators

### Power/Ready

State	Description
<b>Green - solid</b>	System Ready
<b>Green - flashing</b>	System is booting or DIP switch is in console mode
<b>Red</b>	Error condition

### Link 10/100/1000

State	Description
<b>Green</b>	1000 Mbps
<b>Amber</b>	10 /100 Mbps
<b>Off</b>	No LAN connection

### Activity

State	Description
<b>Green</b>	Flashes with activity
<b>Amber</b>	Flashes with activity
<b>Off</b>	No LAN connection

# Installation

## General Cautions and Warnings

**Warning:** Power sources must be off prior to beginning the power connection steps. Read the installation instructions before you connect the unit to its power source.

**Warning:** Ensure that the voltage and current ratings of the intended power source are appropriate for the IOLAN as indicated on the product label.

**Warning:** Ensure that the installation and electrical wiring of the equipment is performed by trained and qualified personnel and that the installation complies with all local and national electrical codes.

**Warning:** The working voltage inputs are designed for operation with Safety extra low Voltage (SELV). Connect only to SELV circuits with voltage restrictions in line with IEC/EN 60950-1:2005 (2nd Edition) + A1:2009 and EN 60950-1: 2006 + A11:2009

**Warning:** If this equipment is used in a manner not specified by the manufacturer, the protection provided by the equipment may be impaired.

## Connecting the Power

The SDG4 and the STG4 models connect to power using the power adapter that came with your IOLAN. If using a SDG4 TX with the Terminal Block connector use the instructions below to connect to power. The Terminal Block cannot be removed from the IOLAN.

### Connecting the barrel connector

Plug the power adapter into a power socket and connect the barrel connector end into the IOLAN. The IOLAN will perform a power up sequence. The Power/Ready LED should show a solid green. See [LED Indicators](#) for power up sequence.

### Connecting the terminal block connector

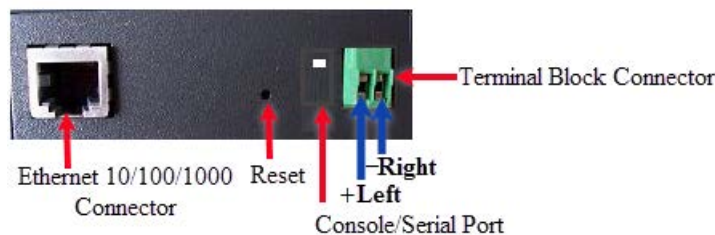

1. Ensure power is NOT applied to the wires prior to connection.
2. On each end wire (16-20 AWG), remove the insulation from the copper wire 5 mm (3/16 of an inch).
3. Loosen the left screw on the top of the terminal connector block, then insert your positive (+) wire into the left terminal and screw it down tight (.51Nm torque). Loosen the right screw on the top of the terminal connector block, then insert your negative (-) wire into the right terminal and screw it down tight (.51Nm torque).
4. Turn on power at source. See [LED Indicators](#) for power up sequence.



## Grounding and Power Cord Relief clip

If your installation requires additional grounding, follow this procedure.

Grounding the chassis requires the following items:

- One grounding lug (not provided)
- One 12AWG wire (not provided)

Follow the manufacturers instructions for attaching the ground wire to the grounding lug.

1. Attach the grounding lug to the chassis and secure with the grounding screw provided. See Figure 1.
2. Attach the power cord relief clip as shown in Figure 2.

Grounding Screw



Figure 1

Power Cord Strain Relief Clip



Figure 2

## Connecting the Serial Ports

The Serial ports are normally used to connect serial devices. Serial port 1 can also be used as a console to fully configure and manage the IOLAN.

The serial ports are an 10-pin, RJ45 connector. For complete details on the pinout of the ports see [Appendix D - Cabling and Connectors](#)

### Console Port Mode

1. Power off the IOLAN.
2. Set the “console/serial DIP switch” to the console (down) position.
3. Connect the power and allow the IOLAN to complete the boot up sequence.
4. Connect an 8 pin cable between the IOLAN serial port 1 and the RJ-45 to DB-9 converter shipped with your IOLAN. Connect the DB-9 end of the converter to the COM port of your PC.
5. Choose Start > Control Panel > Systems or equivalent on the Windows Operating System you are using.
6. Click the Hardware tab and choose Device Manager, Expand the Ports (COM & LPT) section. This will expand the drop down to show the number of com ports on your system. Connect the cable to one of these ports (probably COM1 or COM2).
7. Start a terminal-emulation program (such as Putty or SecureCRT) on the COM port where you have connected the cable PC.
8. Configure this COM port within the terminal emulation program with the following parameters:
  - 9600 baud

- 8 data bits
- 1 stop bit
- No parity
- None (flow control)

9. You should now be able to see all messages sent to the console of the IOLAN.

### **Serial Port Mode**

Serial mode is used when the IOLAN acts as a communication sever to provide access to the serial device which is connected to its serial port. For the different methods which can be used to connect to the serial device see the IOLAN User's Guide. When serial port 1 is in this mode, all console mode functions are disabled on the port.

To set serial port 1 in this mode, ensure that the "console/serial DIP switch" is in the serial (up) position.

## **Connecting Data Ports**

### **Ethernet Connection**

By default the 10/100/1000 Ethernet port will automatically set itself up to match the speed of the port it is connected to. If auto negotiation is not supported by that port then, the port can be configured to operate at a fixed speed and duplex settings.

To connect to 10Base-T, 100Base-TX or 1000Base-T follow these steps:

1. Connect a straight through Ethernet cable from the IOLAN's Ethernet port to an 10/100/1000 RJ45 port on the network hub/switch.
2. Once the IOLAN is connected and the link is established, the link LEDs will turn on. These LEDs will indicate whether you have a 10, 100 or 1000 Mbps link to your hub/switch. See. ([LED Indicators](#)) for more details.

## Ethernet Connector - 8-pin RJ-45

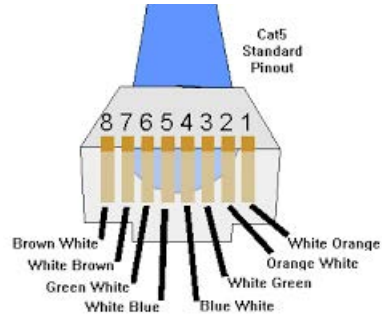
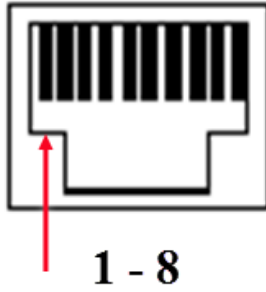

### MDI Port Pinouts

Pin	Signal
1	Tx+
2	Tx-
3	Rx+
6	Rx-

### MDI-X Port Pinouts

Pin	Signal
1	Rx+
2	Rx-
3	Tx+
6	Tx-

# Operation

## Rebooting the IOLAN

To reset the IOLAN insert a paper clip into the “Reset” hole, then gently press inwards. If the button is released quickly the IOLAN will reboot, if the button is pressed for more than three seconds the IOLAN will be returned to factory defaults.

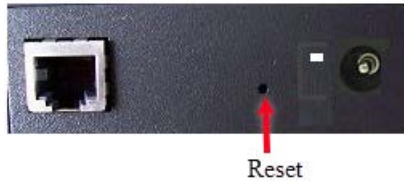

## Resetting the IOLAN to Factory Default Configuration

To reset the configuration of the IOLAN, insert a paper clip into the inset hole labelled as “Reset” and hold the reset button between 3 and 10 seconds, the IOLAN will reset the configuration to factory default (either the Perle or custom default configuration). If you hold the reset button greater than 10 seconds, then the IOLAN will reset the configuration to the Perle factory default configuration.

## Configuring the IOLAN

The IOLAN can be configured, operated and monitored using any of the following methods. See IOLAN Secure User's Guide for more details.

### CLI

A text-based Command Line Interface based on industry standard syntax and structure. The CLI can be accessed from the console port without a valid IP address for the initial setup. Once an IP address has been assigned the IOLAN can also be accessed by Telnet, SSH, SNMP or the Web interface.

### Web Manager

The Perle Web Manager is an embedded Web based application that provides an easy to use browser interface for configuring and managing the IOLAN. Once an IP address has been assigned/configured on IOLAN, it can be accessed through any standard desktop web browser.

### Device Manager

This is a Windows based utility that provides the ability to do either an initial setup (out of the box) or to configure and manage the IOLAN. In order to use this utility the IOLAN must be connected to your network. You can download the Device Manager software from our website at [www.perle.com](http://www.perle.com).

# Appendix A - Technical Specifications

## IOLAN SDG4/SDG4 TX/STG4 Port Technical Specifications

Power Input	12/24VDC (9-30VDC)
Power Supply Options	Power via external power 9-30v DC (SDG4/STG4), 4.8 Watts, terminal block connector (STG4 TX)
Power Consumption@24V DC (Watts)	4.8 Watts
Power IOLAN over Serial	9-30v DC with RJ45 model SDG4/SDG4 TX models
Operating Temperature	-0°C to 55°C -32°F to 131°F
Operating Temperature - Extended Temperature (T model)	-40°C to 74°C -40°F to 165°F
Storage Temperature	-40°C to 66°C -40°F to 150°F
Operating and Storage Humidity	5 to 95% (non condensing)
<b>Regulatory Approvals</b>	
<b>Emissions</b>	
	CFR47 FCC Part 15 Subpart B:2016 ICES-003:2016 EN550032:2015 (CISPR32:2015)
<b>Immunity</b>	
	EN61000-4-2:2009 EN61000-4-3:2006/A2:2010: RF Electromagnetic Field Modulated EN61000-4-4:2004 Fast Transients EN61000-4-5:2006 Surge EN61000-4-6:2009 RF Continuous Conducted EN61000-4-8:2010 Power-Frequency Magnetic Field EN61000-4-11:2004 Voltage Dips and Voltage Interruptions EN61000-3-2:2014, Limits for Harmonic Current Emissions EN61000-3-3:2013, Limits of Voltage Fluctuations and Flicker EN55024:2010/CISPR24:2010
<b>Safety</b>	
	IEC 62368-1:2014 (second edition) EN 62368-1:2014 CSA/UL 62368-1:2014

# Appendix B - Mechanical Drawing

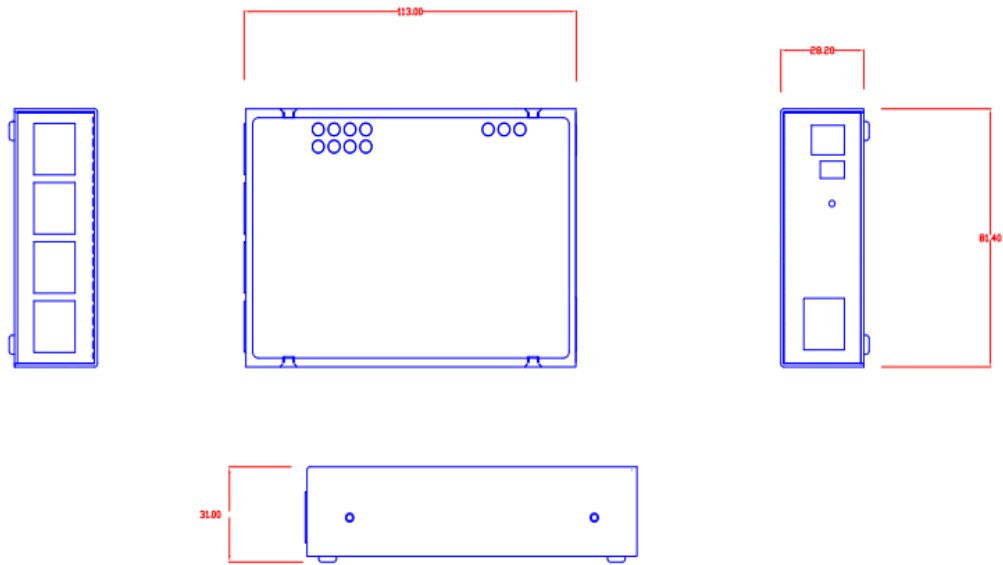

The Wall/Rack Bracket can attach to either side of the IOLAN

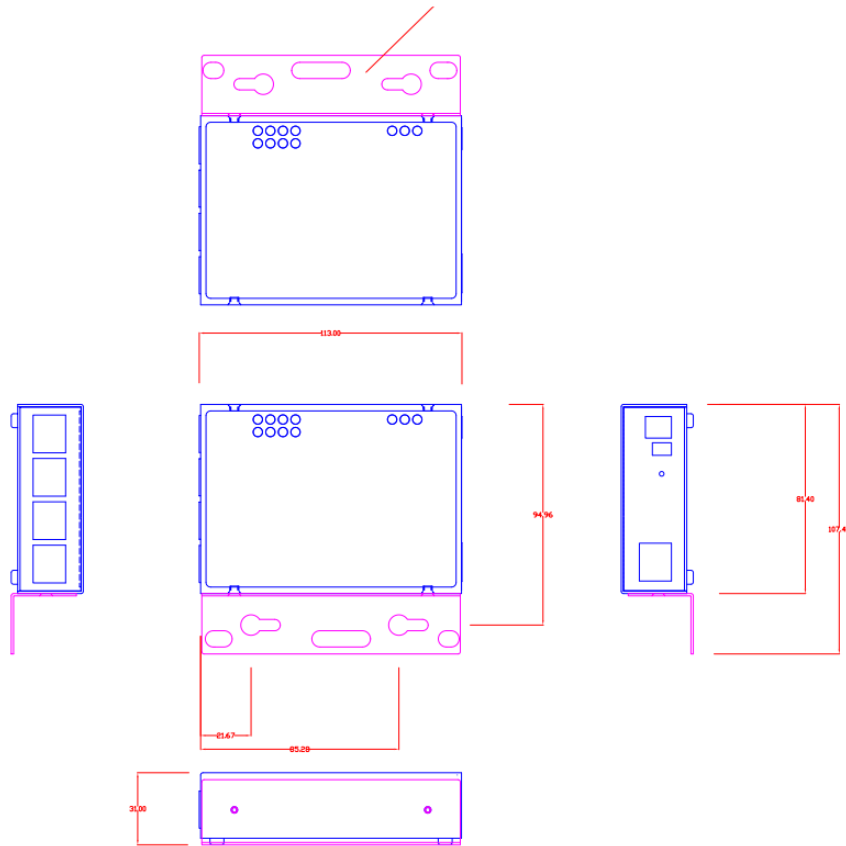

# Appendix C - Labels (Sample)

 IOLAN SDG4  
Model: IOLAN SDS4 GR

P/N: 04031850  
S/N: 80-370917M100022



Input: 9-30VDC 1.0A max, Class2

 **UL** **US**  
**LISTED E160409**  
Ethernet to Serial Device

MAC : 0080D4 911A9D      Made in Canada

 IOLAN SDG4 TX  
Model: IOLAN SDS4T GR

P/N: 04031870  
S/N: 80-400917T00020



Input: 9-30VDC 1.0A max, Class2

 **UL** **US**  
**LISTED E160409**  
Ethernet to Serial Device

MAC : 0080D4 911A89      Made in Canada



# Appendix D - Cabling and Connectors

## Connecting Serial Devices

Ensure you have the appropriate cable for connecting your serial devices to the serial ports on the IOLAN.

### IOLAN RJ45 Connector

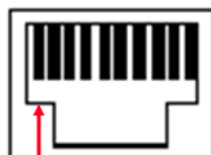

Pinout 10-Pin	Pinout 8-Pin	EIA-232	EIA-422	EIA-485 Full Duplex	EIA-485 Half Duplex
1		Power In	Power In	Power In	Power In
2 (in)	1 (in)	DCD			
3 (out)	2 (out)	RTS	TxD+	TxD+	TxD+/RxD+
4 (in)	3 (in)	DSR			
5 (out)	4 (out)	TxD	TxD-	TxD-	TxD-/RxD-
6 (in)	5 (in)	RxD	RxD+	RxD+	
7	6	GND	GND	GND	GND
8 (in)	7 (in)	CTS	RxD-	RxD-	
9 (out)	8 (out)	DTR			
10		Power Out	Power Out	Power Out	Power Out

The Power In pin, pin 1 can be 9-30V DC. STG4 is a RS-232 RJ45 model only.

### Hardware Options (IOLAN SDG4/SDG4 TX)

The IOLAN contains jumpers that you might need to set before you configure it and put it into production. You can set the Power Out pin, pin 10 to a fixed 5V DC output or to the external adapter output; this can range from 9-30V DC (if an external adapter is shipped with the IOLAN, it has a 12V DC output). The Power Out pin is only supported on the SDG4/SDG4 TX model

The serial port on the IOLAN SDG4/SDG4 TX can also operate in either EIA 232, 422 or 485 mode. This is a software configuration (See the IOLAN User's Guide for information on setting this parameter in your IOLAN firmware). If EIA 422 or 485 is selected, the line termination may need to be set.

Line Termination is not necessary unless the IOLAN's are the end points.

To change the hardware settings, do the following:

1. Unplug the IOLAN from the electrical outlet and disconnect everything from the unit.
2. Open the case by unscrewing the four side screws, two on each side, and lifting off the top of the case.

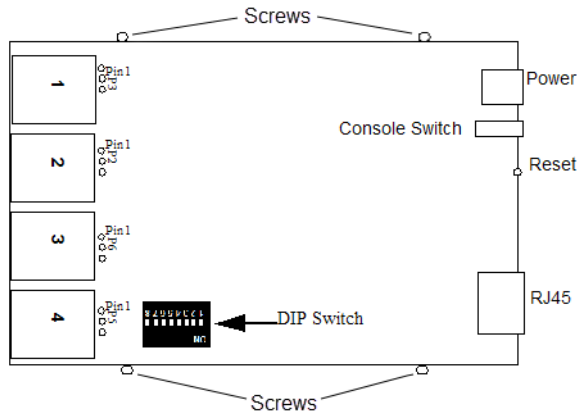

3. To change the power pin out, locate the set of three pins associated with the line you want to set (Serial port 1 is P3; Serial port 2 is P2, Serial port 3 is P6 and Serial Port 4 is P5. For fixed 5V DC output, jumper pins 1 and 2. For the output to equal the external adapter input, jumper pins 2 and 3.
4. To turn line termination ON, locate the DIP switches above Serial Port 4.
  - To terminate Serial Port 1 for Full Duplex set DIP switch 1 ON. To terminate for Half Duplex set DIP switch 2 to ON.
  - To terminate Serial Port 2 for Full Duplex set DIP switch 3 ON. To terminate for Half Duplex set DIP switch 4 to the ON position.
  - To terminate Serial Port 3 for Full Duplex set DIP switch 5 ON. To terminate for Half Duplex set DIP switch 6 ON.
  - To terminate Serial Port 4 for Full Duplex set DIP switch 7 ON. To terminate for Half Duplex set DIP switch 8 to ON.
5. Close the IOLAN case by replacing the case lid and the four screws. You can now power the IOLAN with the new settings.

## Appendix E - IOLAN Maintenance

- Ensure there is clearance of 50.8mm (2 inches) on all sides of the IOLAN to provide proper airflow through the unit
- Do not use solvents or cleaning agents on this unit
- Keep vent holes clear of debris
- If case gets dirty wipe with a dry cloth
- Ensure all cables are in working condition

# Contacting Perle Systems Limited

## Contacting Technical Support

Contact information for the Perle Technical Assistance Center (PTAC) can be found at the link below.

[https://www.perle.com/support\\_services/support\\_request.shtm](https://www.perle.com/support_services/support_request.shtm)

## Warranty / Registration

This product is covered by the Perle IOLAN SDG Warranty. Details can be found at:

[https://www.perle.com/support\\_services/warranty.shtml](https://www.perle.com/support_services/warranty.shtml)